

Instructions for installation,
use e maintenance

ELECTRIC CHIPS SCUTTLE

ADN 658



CHARACTERISTICS

Supplied by:

Date:

Customer Service:



FAX

e-mail

INDEX

| | |
|---|----|
| 1 Diagram | 4 |
| 2 Features of the appliances | 5 |
| 3 Technical data | 5 |
| 4 Installation instructions | 6 |
| 4.1 Safety rules | 6 |
| 4.2 Structure, framework and safety devices of the appliances | 6 |
| 4.3 Assembly | 6 |
| 4.3.1 Installation premises | 6 |
| 4.3.2 Statutory regulations and technical requirements | 6 |
| 4.3.3 Installation | 6 |
| 4.3.4 Electrical connection | 6 |
| 4.3.5 Equipotential | 6 |
| 5 Operation preparation | 7 |
| 5.1 Preparation and Start-up | 7 |
| 5.1.1 Start-up | 7 |
| 5.1.2 Operator training | 7 |
| 5.2 Maintenance | 7 |
| 5.3 Replacing parts | 7 |
| 6 Instructions for use | 7 |
| 6.1 Safety, cleaning and repair rules | 7 |
| 6.2 Start-up | 8 |
| 6.3 Cleaning and taking care of the machine | 8 |
| 6.4 Turning the appliance off in case of breakdown | 8 |
| 6.4.1 What to do in case of failure | 8 |
| 6.4.2 What to do in case of prolonged period of disuse | 8 |
| 6.5 Appliance care and frequency of maintenance | 8 |
| 6.6 Recommendations for handling "stainless steel" industrial kitchens | 8 |
| 6.6.1 Useful information on "stainless steel" | 8 |
| 6.6.2 Warnings and advice for maintenance of "stainless steel" appliances | 8 |
| 6.6.3 WEEE Directive | 10 |
| 7 Appendix: Electrical diagram | 11 |



1 - DIAGRAM

ADN 658

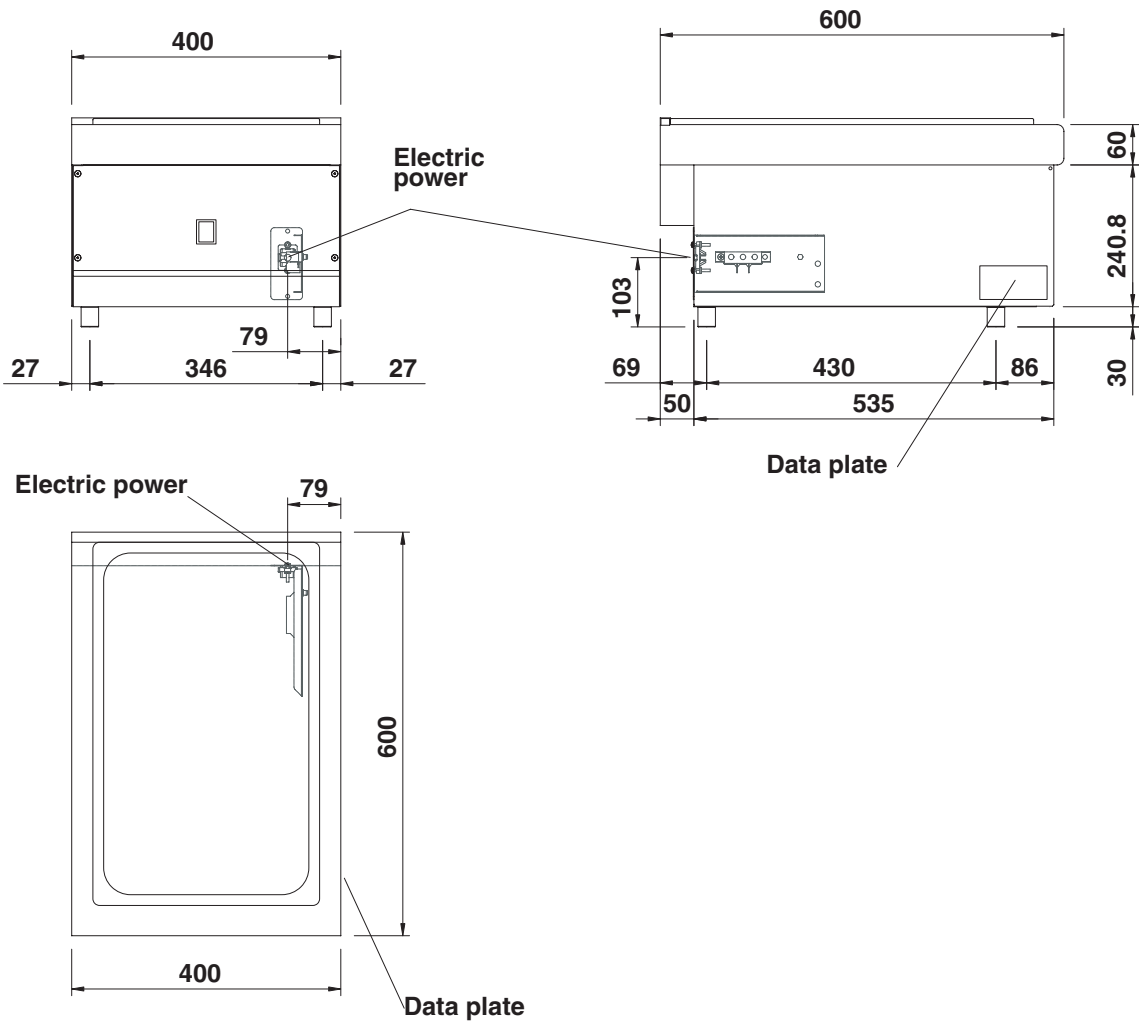

2 - CHARACTERISTICS OF THE APPLIANCES

These appliances are used for professional purposes.

Installation, repair and use must be carried out by expert personnel.

The data plate is located on the appliance and contains all the data needed for installation.

Beware of inexpert handling.

| | | | | | | | | | | | | |
|--|------------|---------|-----|-----|---------------|-----|-----------------------------|-----------------------------|-----------------------------|-----------------------------|-----------------------------|-----------------------------|
| | CAT/KAT | GAS/GAZ | G30 | G31 | G20 | G25 | SE <input type="checkbox"/> | FI <input type="checkbox"/> | DK <input type="checkbox"/> | CZ <input type="checkbox"/> | SK <input type="checkbox"/> | SI <input type="checkbox"/> |
| | I12H3B/P | P mbar | 30 | 30 | 20 | - | IT <input type="checkbox"/> | CH <input type="checkbox"/> | PT <input type="checkbox"/> | | | |
| | I12H3+ | P mbar | 30 | 37 | 20 | - | ES <input type="checkbox"/> | IE <input type="checkbox"/> | GB <input type="checkbox"/> | GR <input type="checkbox"/> | | |
| CE | I12L3B/P | P mbar | 28 | 37 | 20 | - | | | | | | |
| | I12L3B/P | P mbar | 30 | 30 | - | 25 | NL <input type="checkbox"/> | | | | | |
| | I12ELL3B/P | P mbar | 50 | 50 | 20 | 20 | DE <input type="checkbox"/> | | | | | |
| TIPO/TYP | I12E+3+ | P mbar | 28 | 37 | 20 | 25 | FR <input type="checkbox"/> | BE <input type="checkbox"/> | | | | |
| MOD. | I12H3B/P | P mbar | 50 | 50 | 20 | - | AT <input type="checkbox"/> | CH <input type="checkbox"/> | | | | |
| ART. | I12E | P mbar | - | - | 20 | - | LU <input type="checkbox"/> | | | | | |
| CE N. | I12H3B/P | P mbar | 30 | 30 | - | - | EE <input type="checkbox"/> | LV <input type="checkbox"/> | LT <input type="checkbox"/> | | | |
| N. | I12H3+ | P mbar | 28 | 37 | 20 | - | EE <input type="checkbox"/> | LV <input type="checkbox"/> | LT <input type="checkbox"/> | | | |
| % Qn kW | I3B/P | P mbar | 30 | 30 | - | - | NO <input type="checkbox"/> | MT <input type="checkbox"/> | CY <input type="checkbox"/> | IS <input type="checkbox"/> | HU <input type="checkbox"/> | |
| MOD. | I3+ | P mbar | 28 | 37 | - | - | CY <input type="checkbox"/> | | | | | |
| Predisposto a gas - Gas preset - Prevu pour gaz: Eingestellt für Gas - Preparado para gas - Geschickt voor: | | | | | | | | | | | | |
| VAC | kW | | Hz | | MADE IN ITALY | | | | | | | |
| THE APPLIANCE MUST BE CONNECTED IN COMPLIANCE WITH THE LAWS IN FORCE AND INSTALLED IN A WELL-VENTILATED ROOM. READ THE INSTRUCTION MANUALS BEFORE INSTALLING AND USING THE APPLIANCE. THE APPLIANCE MUST BE INSTALLED BY QUALIFIED PERSONNEL. | | | | | | | | | | | | |

3 - TECHNICAL DATA

| Model | Description | Dimensions in mm. (LxDxH) | N° Tank | Capacity |
|----------------|------------------------|---------------------------|---------|--------------------|
| ADN 658 | Electric chips scuttle | 400 x 600 x 270 | 1 | GN 1/1 h 15 / 23 l |

TABLE 1

| Model | Total Power | Voltage rating | Lead wire Section |
|----------------|-------------|----------------|-------------------------|
| ADN 658 | 0.35 kW | 230V | 3 x 1.5 mm ² |

4 - INSTALLATION INSTRUCTIONS

4.1 Safety rules

- Only a local gas utility technician is authorized to carry out gas installations and connections. The statutory regulations (applied in Germany VDE, Austria ÖVE, Switzerland SEV, etc.) and connection conditions performed by the gas utility must be strictly observed.
- In compliance with international regulations, when connecting the appliance to the mains power supply, a device with a minimum aperture of 3 mm between contacts must be fitted upstream of the appliance, allowing omnipolar disconnection of the appliance from the mains. Also, a high-sensitivity automatic differential switch must be installed which protects against direct or indirect contact with live electrical parts and against current leakage (maximum current leakage permissible by regulations is 1 mA/kW).
- Connection to a power balance system for the installation in a all is given through a connection point. Follow the VDE 0100 T 410 connection rules or local rules.
- Compare technical datas on grey stickers to those written on this manual and present power supply.
- Do not bend, crush or damage the cables against sharp corners.
- Lay the cables so as to avoid contact with extremely hot surfaces.
- Connection to the grid must be carried out with at least a cable type NYM or H07RN-F.
- The cable - which is totally sheathed - must be led inside the appliance through the cable clamp and cable raceway installed on the appliance.
- Ventilation system installation can be carried out only by expert personnel.
- If the appliance is to be installed near walls, dividing walls, kitchen equipment or decorative panelling, these should be in non-flammable material. If not, all appliances must be coated with thermal-insulation fireproof material. Make sure that all fire prevention standards and safety precautions are strictly adhered to.

4.2 Structure, equipment and safety devices of the unit

Robust steel frame.

Steel outer panelling.

The water is heated by heating element in stainless steel, built to withstand thermomechanical stress.

4.3 Assembly

4.3.1 Installation premises

The appliance must be installed in a well-ventilated room, and if possible under a range hood (check current regulations).

The appliance can be installed on its own or with other similar equipment.

If the appliance is to be installed near inflammable walls, a minimum distance of 150 mm around the sides and back should be allowed.

If this distance cannot be obtained, take proper heat-protection action such as fitting tiles or thermal radiation protection material to the walls.

4.3.2 Statutory regulations and technical requirements

During installation of the appliance, the following regulations must be adhered to:

- Relevant legal directives;
- Local building and combustion regulations;
- "Technical rules for gas systems" worksheet;
- "Technical rules for liquid gas" worksheet;
- "Gas installations in industrial kitchens" worksheet;
- Relative accident prevention standards;
- Local gas utility regulations;
- Local building and fire codes.

4.3.3 Installation

Installation, start-up and maintenance should only be carried out by expert personnel.

All work required to install the appliance should be carried out in compliance with all local standards and regulations.

The manufacturers decline all responsibility where poor performance is due to incorrect installation in disregard of the above conditions.

4.3.4 Electrical connection

Before connecting the unit to the mains, check that:

- The mains voltage corresponds to the values shown on the data plate;
- The earth is in working order;
- The power cord is suitable to the electrical input of the appliance (see table 1 pag. 5) and approved. The cord must be at least type H07 RN-F.

The ground wire must be long enough to prevent tug after the cable lead wires in case of raceway breakage.

Also, up the line from the unit, there must be a device with contact opening of at least 3 mm which makes it possible to disconnect the appliance in omnipolar mode.

To this end, for example, safety contactors may be used.

The omnipolar switch must be located near the appliance and be readily accessible.

4.3.5 Equipotential

The appliance must be hooked up to a unipotential system. The required terminal is located near the power cable and it is marked by a tag with a symbol .

 The manufacturers cannot be held responsible for any damage due to inadequate or incorrect installation. Under such circumstances the guarantee will be considered null and void.

5 - SET-UP FOR OPERATION

5.1 Preparation and Start-up

Before starting up the appliance, remove the protective wrapping. Then carefully clean the working surface and the external parts with lukewarm water and detergent, using a damp rag to remove all traces of anti-rust material applied in the factory, then dry with a clean cloth.

5.1.1 Start-up

Before using the appliance for the first time, thoroughly clean out the tank (see the chapter 6.3 "Cleaning and taking care of the machine").

To start up the appliance, see the instructions for regular use.

5.1.2 Operator training

- Explain and show the user how the machine works according to the instructions, and hand him this manual.
- Remind the user that any structural alterations or any building modification or renovation may affect the combustion air supply, thus requiring a second operation check.

5.2 Maintenance

 **Attention! Before doing any repair or maintenance work, unplug the appliance.**

- Never leave the appliance on without water in it!

5.3 Replacing parts











 **All parts must be replaced by authorized technicians only!**

To replace the following parts first remove all the control knobs and control panel (after loosening the fixing screws), then extract the ignition wire.

 **After any maintenance or repair work, replace the control panel and the lower panel.**

6 - INSTRUCTIONS FOR USE

6.1 Safety, cleaning and repair rules

-  • This appliance is used for the preparation of meals at industrial level. Usage and cleaning can be carried out only by expert personnel. Maintenance and repair can be carried out only by skilled technical personnel.
-  • These indications must be communicated to all those concerned during internal training.
-  • Attention! This appliance must be constantly watched over when being used!
-  • Grease and overheated oil can catch fire. Use this appliance only under constant control. Never use water to put out grease or oil!
-  • Parts of the appliance and attachments exposed to food must be cleaned with detergents and rinsed thoroughly with potable water.
-  • Do not clean the appliance using water jets or steam, whether direct or pressurized!
-  • If the room is being cleaned with water/steam jets or high-pressure equipment, it is necessary to switch off the appliance first!
-  • Before starting to clean the appliance, disconnect from the mains.
-  • Do not use inflammable liquid to clean the appliance.
-  • Repairs may be carried out only by skilled personnel.

 • During repairs, the appliance must undergo voltage omnipolar insulation (local switch, i.e. safety load cut-off switch).

 • Noise emission values of the appliance in operation are below 70dB (A). This value is compulsory according to certain national safety standards.

WARNING

 **Attention!** The manufacturer declines all responsibility concerning mistakes included in these instructions due to translating or printing errors: the manufacturer also reserves the right to change the product as he sees fit, though without changing its essential features. The manufacturer declines all responsibility for any non-compliance with the provisions contained in this manual.

6 - INSTRUCTIONS FOR USE

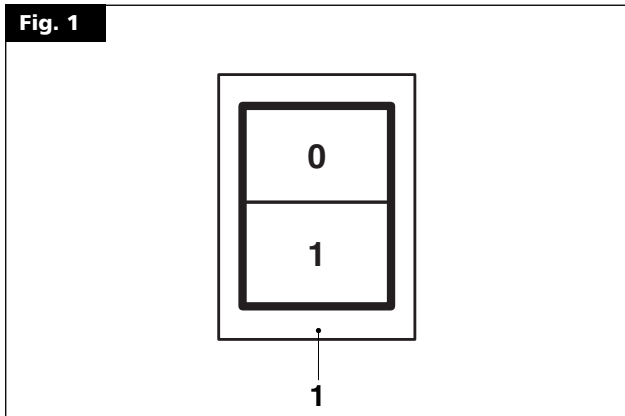

6.2 Start-up

! Before using the appliance for the first time, thoroughly clean the tank with lukewarm water and detergent, using a soft cloth to eliminate all trace of the rust-proofing applied in the workshop. Dry with a clean cloth.

Turn on the main switch upstream of the appliance.

Turn on switch (pos. 1 fig. 1) of the appliance, come on shows that the appliance is on.

To turn the appliance off, turn off switch.

6.3 Cleaning and taking care of the machine

- Never clean the appliance with jets of water, whether direct or pressurised!
- Never clean the appliance before it has cooled down.
- Rinse the surface with clean water and a soft cloth to get rid of all traces of detergent.
- When finished using the appliance, it should be cleaned thoroughly every evening.
- Before starting to clean the appliance, disconnect from the mains. The surfaces and steel parts should be washed in warm water using a neutral detergent. Avoid using abrasive or corrosive detergents which could damage the steel.
- Thoroughly dry the appliance.
- Cleaning the appliance daily guarantees perfect long-term operation.

6.4 Turning the appliance off in case of breakdown

6.4.1 What to do in case of failure

In case of breakdown or malfunctioning or failure turn off the appliance. Switch off any electric power. Call the service centre.

6.4.2 What to do in case of prolonged period of disuse

When the appliance is not to be used for a long time, clean thoroughly, as instructed in the chapter 6.5 "Appliance care and frequency of maintenance", switch off any electric power.

6.5 Appliance care and frequency of maintenance

! Attention! When cleaning, carefully avoid washing the appliance with direct water jets or high-pressure water!

Cleaning must be performed when the appliance is cold.

Thorough daily cleaning of the appliance, after disconnecting it, will keep it in perfect working order and make it last longer. All steel parts should be cleaned with water and a detergent, using a damp cloth; do not use abrasive substances or corroding detergents.

Do not use steel wool, which could cause rust to form.

For the same reason, avoid touching the appliance with anything made of iron. Do not clean with sandpaper and lubricating gel paper. If absolutely necessary, you may use pumice powder.

If the appliance is extremely dirty, use a synthetic sponge (i.e. Scotchbrite sponge).

After cleaning the appliance, rinse with clean water and wipe with a clean cloth.

All maintenance and repair work must be carried out by authorized technicians only.

The appliance must be checked at least once a year. For this reason, a service agreement contract is recommended.

6.6 Recommendations for the treatment of stainless "steel industrial" kitchens

6.6.1 Useful information on "stainless steel"

Industrial kitchens are generally made of "stainless steel" having the following material codes:

- 1.4016 or 1.4511 = magnetizable chromed steels
- 1.4301, 1.4401 and 1.4571 = non-magnetizable chromed steels

Chromed steels have favourable thermo-technical characteristics. In fact, they have less of a tendency to warp due to the effect of heat. Chrome-nickel steels, instead, have good corrosion resistance features.

"Stainless steel" corrosion resistance is given by an inactive coat that builds up on the surface by coming into contact with oxygen.

The oxygen in the air is already enough to build up the inactive coat that allows automatic removal of anomalies and damage due to mechanical actions. The inactive coat builds up or re-builds up faster if the steel comes in contact with running water containing oxygen.

A more powerful effect is given by oxidative acids (nitric acid, oxalic acid). These acids are used if the steel has undergone strong chemical stresses, hence generally losing its inactive coat.

The inactive layer can be chemically damaged or jeopardized by reducing agents (oxygen consumption) if they come in contact with the steel, concentrated or at high temperatures. These active substances include for instance:

- saline and sulphurous substances
- chlorides (salts)
- concentrated spices such as mustard, vinegar essences, soup cubes, kitchen salt solutions, etc.

More damage can be caused by:

- outside rust (i.e. from other components, tools or incipient rust)
- iron particles (i.e. file dust)
- contact with non-ferrous metals (element build up)
- lack of oxygen (i.e. no air inlet, water lacking oxygen).

6.6.2 Warnings and advice for maintenance of "stainless steel" appliances

- "Stainless" steel equipment surfaces must be kept clean and in contact with air at all times. When not running, keep appliance doors open so as to allow air to run through it.
- Regularly remove calcium, grease, starch, and egg white deposits where rust may build up if there is lack of air. Do not

6 - INSTRUCTIONS FOR USE

use bleaching products or products containing chloride. Follow all indications given by the company concerning special soaps and cleaning methods to be used for the appliance. If no specific cleaning recommendations are available, it is necessary, however, to use detergents having a low chloride content. After cleaning, remove all soap residues with plenty of clean water and thoroughly dry the surfaces.

- Minimize contact of "stainless steel" with concentrated acids, spices, salts, etc. Even acid vapours coming from cleaning the tiles favour "stainless steel" corrosion.
- Particularly for pots and multiple appliances, it is not recommended to load the cooking chamber only with food having a high salt content.

It is preferable to cook different food together, i.e. fatty dishes or vegetables containing acids.

- Avoid damaging the "stainless steel" surface, in particular with different metals. Residues from other metals help build up the formation of chemical microelements that may cause rust. At any rate, it is appropriate to avoid contact between iron and steel since it produces rust. Any contact between "stainless steel" and iron (steel wool, pipeline chips, chalybeate waters) can start corrosion phenomena.
- As for mechanical cleaning, it is recommended to use only steel wool or natural, plastic or steel bristle brushes. Steel wool or brushes with "stainless steel" can cause rust due to rubbing. Newly formed rust spots can be removed with slightly abrasive liquid soaps or fine-grained sand paper. Larger rust spots can be removed with 2-3% of hot oxalic acid solution. If these cleaning products do not do the job, a nitric acid (10%) treatment is required.



Attention! These treatments can be carried out only by expert personnel according to current regulations!

6.6.3 The 2002/96/EC (WEEE) Directive: information to users

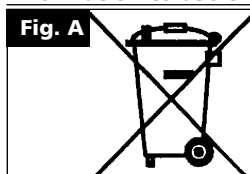

This informational note is meant only for owners of equipment marked with the symbol shown in fig. A on the adhesive label featuring the technical specifications applied on the actual product (the label also giving the serial number).

This symbol indicates that the product is classified, according to the regulations in force, as an item of electrical and electronic equipment and conforms to EU Directive 2002/96/EC (WEEE) meaning that, at the end of its service life, it must be treated separately from domestic waste, i.e. it must be handed in free of charge to a separate waste electrical and electronic equipment collection centre or returned to the reseller when buying a new equivalent item of equipment.

The user is responsible for delivering the unit at the end of its life to the appropriate collection facilities. Failure to do so shall result in the user being subject to the penalties prescribed by the legislation in force on waste.

Suitable separated collection so that the unit no longer used can be sent off for environmentally compatible recycling, treatment and disposal helps avoid possible negative effects on the environment and on health and facilitates the recycling of the product's component materials.

For more detailed information on available collection systems, contact the local waste disposal service or the shop you purchased the unit from.

Producers and importers fulfil their responsibility for environmentally compatible recycling, treatment and disposal both directly and by joining a collective scheme.

NOTES

7 - APPENDIX: ELECTRICAL DIAGRAMS

ADN 658

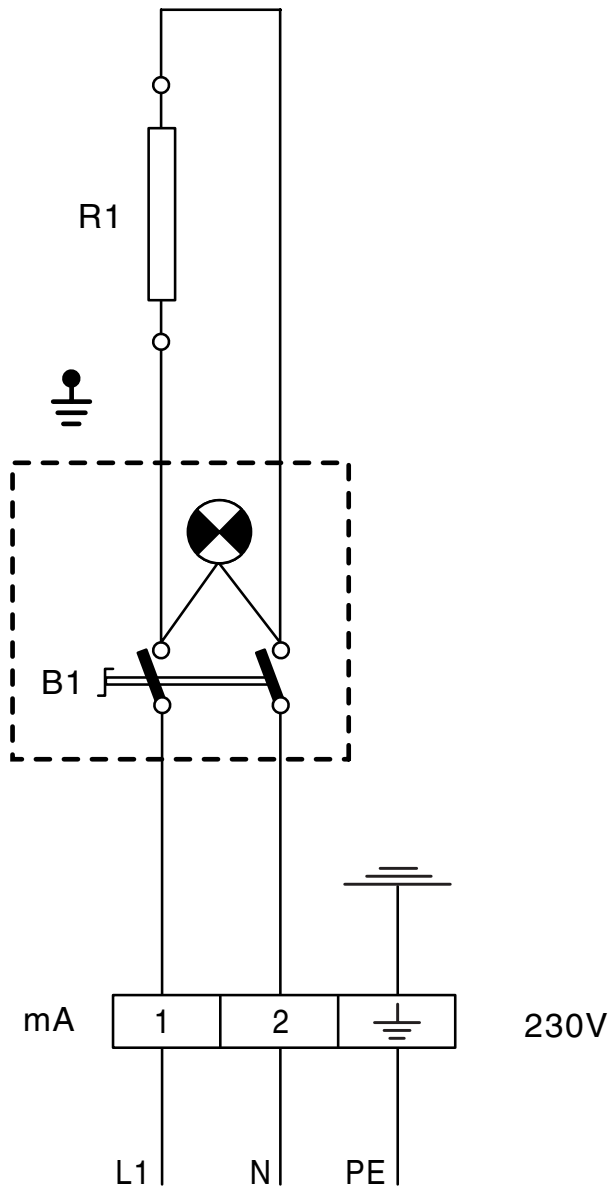

- mA** Terminal board
 - B1** Switch
 - R1** Heating element 350 W
- Total power: 0.35 kW

WARNING

THE MANUFACTURER CANNOT BE HELD RESPONSIBLE
FOR ANY INACCURACIES IN THIS BOOKLET DUE
TO COPYING OR PRINTING ERRORS.
DUE TO ITS POLICY OF CONTINUAL PRODUCT IMPROVEMENT,
THE MANUFACTURER RESERVES THE RIGHT
TO MAKE ANY CHANGES DEEMED NECESSARY.
**THE MANUFACTURER CANNOT BE HELD RESPONSIBLE
IF THE INSTRUCTIONS CONTAINED IN THIS MANUAL
ARE NOT OBSERVED.**